

Part Number

MECHANICAL PENCILS
Mechanisms and Parts

All Models

Mechanism Assemblies

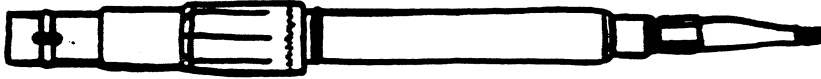

666-931

61 (Mechanical)
"51"
41

US\$ -.75

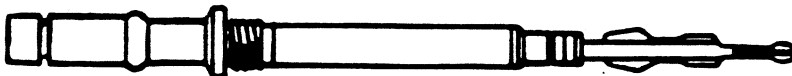

586-881

"51" (Continuous Feed)
Complete Movement Assembly.

1.10



~~609-866~~

725-866-1

609-866-A

All Rotary Models except Parkette
and "51" Semi
SUPER "21" (Mechanical)

-.50

-.50

Mechanism Sub-Assemblies and Parts



586-866

"51" Eraser Cup Holder (Continuous Feed)

-.50



586-827

"51" Actuating Clutch (Continuous Feed)

-.15

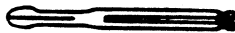

586-731

"51" Point Clutch (Continuous Feed)

-.40



586-754

"51" Spring (Continuous Feed)

-.05



586-867

"51" Assembly Lock (Continuous Feed)

-.05

717-881

Mechanical Pencil - 195

.40
Page 40

Part Number

MECHANICAL PENCILS
Points



666-705

61, All Gold-filled Models Gold Electroplated
(Mechanical)
"51" Gold-filled - *except Insignia*
(Mechanical)

All Models

US\$ ~~1.30~~



693-705

61, All Nickel Trim Models Chrome Plated
(Mechanical)
"51"
41

-.20



572-870

"51" Presidential Gold-filled
"51" Insignia
(Continuous Feed)

1.20

570-870

"51" Flighter Chrome Plated
"51" Insignia
(Continuous Feed)

-.45



586-870

"51", for plastic barrels Chrome Plated
(Continuous Feed)

-.40



G-295-850

"51", All Gold-filled Models Gold-filled
(Old Style Rotary)
Vacumatic

-.25

C-487-850

"51", except "51" Special Chrome Plated
(Old Style Rotary)
Vacumatic

-.20



576-705

"21" Custom Chrome Plated

-.30



~~435-705-1~~

725-705

"51" Special (Rotary) Chrome Plated
SUPER "21" (Mechanical)
"21" Deluxe (Rotary)
"21" Standard (Rotary)
"21" Special (Rotary)

-.20

*all "51" models (except continuous feed
and mechanical models)
Vacumatic*

Add the following as Page 41A

Export Wholesale
Net Prices

MECHANICAL PENCILS
Points

Part Number

728-705	61 Presidential 61 Insignia	Gold Electroplated	US\$ -.60
755-705	Executive Gold-fill	Gold Electroplated	-.30
725-705	Executive Lustraloy	Chrome Plated	-.30
779-705	61 Jet Fighter	Penic Point	.20

Part Number

LIQUID LEAD PENCILS
Caps and Clips

61 Models



665-841	61 Heirloom	Laminated Green and Pink Gold-filled	US\$ 4.75
665-941	Cap less Clip		4.00
912-653-721-1	Clip	Yellow Rolled Gold Plate	-.75
659-721		<i>Gold Electroplated</i>	<i>.75</i>
770-721			
664-841	61 Heritage	Laminated Yellow Gold-filled and Sterling Silver Filled	3.75
664-941	Cap less Clip		3.00
912-653-721-1	Clip	Yellow Rolled Gold Plate	-.75

659-721



698-841	61 Legacy	Nickel Laminated with Narrow Silver Stripes between Laminations	2.50
687-941	Cap less Clip		2.00
911-653-721-1	Clip	Chrome Plated	-.50

653-721-1

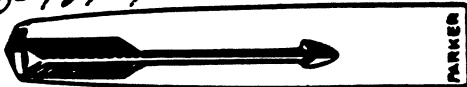

692-841	61 Standard	Bright Lustraloy Finish	2.25
692-941	Cap less Clip		1.75
911-653-721-1	Clip	Chrome Plated	-.50
<i>653-721-1</i>			
663-841	61 Deluxe	Satin Lustraloy Finish, Rolled Gold Plate Trim	2.50
663-941	Cap less Clip		1.75
912-653-721-1	Clip	Yellow Rolled Gold Plate	-.75

659-721

61 Cap less Clip contains Outer Cap, Cap Assembly Bushing and Cap Liner Assembly.

LIQUID LEAD PENCILS
Caps and Clips

Part Number

"51" Aero-metric Models

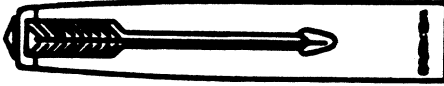
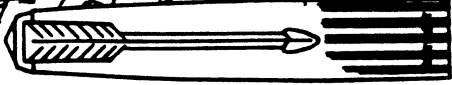
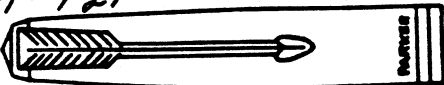
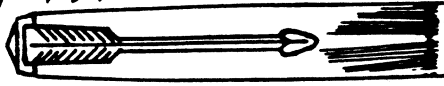
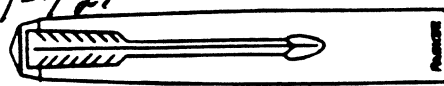
			
572-841	"51" Presidential	14K Gold	US\$ 19.00
572-702	*Cap less Clip		16.00
919-596-721	Clip	14K Gold	3.00
599-721-600-721			
			
570-841	"51" Insignia Aero-metric, Std.	Gold-filled	4.25
570-702	*Cap less Clip		3.50
918-596-721	Clip	Rolled Gold Plate	-.75
597-721-583-721		<i>Gold Electroplated</i>	
650-841	"51" Insignia Aero-metric, Demi	Gold-filled	4.25
625-702	*Cap less Clip		3.50
918-596-721	Clip	Rolled Gold Plate	-.75
597-721			
			
571-841	"51" Fighter	Satin Lustraloy Finish, Gold-filled Band	2.25
571-909	*Cap less Clip		1.50
918-596-721	Clip	Rolled Gold Plate	-.75
597-721			
			
646-841	"51" Aero-metric, Std.	Gold-filled	3.50
646-941	Cap less Clip		2.75
918-596-721	Clip	Rolled Gold Plate	-.75
597-721			
647-841	"51" Aero-metric, Demi	Gold-filled	3.50
647-941	Cap less Clip		2.75
918-596-721	Clip	Rolled Gold Plate	-.75
597-721			
			
633-841	"51" Aero-metric, Std.	Satin Lustraloy Finish	2.00
633-941	Cap less Clip		1.50
917-596-721	Clip	Chrome Plated	-.50
596-721			
641-841	"51" Aero-metric, Demi	Satin Lustraloy Finish	2.00
641-941	Cap less Clip		1.50
917-596-721	Clip	Chrome Plated	-.50
597-721			

*"51" Cap less Clip contains Outer Cap only.

Other Caps and Clips contain Outer Cap, Liner and Bushing Assemblies.

Part Number

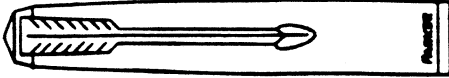

LIQUID LEAD PENCILS
Caps and Clips

"51" Special Models

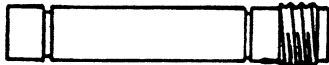

626-841	"51" Special, Std.	Bright Lustraloy Finish	US\$ 1.75
626-941	Cap less Clip		1.25
917-596-721 596-721	Clip	Chrome Plated	-.50
601-841	"51" Special, Demi	Bright Lustraloy Finish	1.75
601-941	Cap less Clip		1.25
917-596-721 596-721	Clip	Chrome Plated	-.50

"51" Special Cap less Clip contains Outer Cap, Liner and Bushing Assembly.

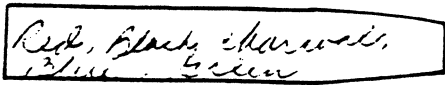
653-938	 Cap Assembly Bushing	<i>61 Parts 2-1</i> <i>Category # 1118 6-</i> <i>10-18-50</i>	-.05
653-950	 Connector & Eraser Cup Holder		-.25
653-870	 Barrel Point Assembly (chrome point with chrome trim)		-.30
659-870	(chrome point with gold filled trim)		-.30
663-704	 Barrel	<i>Red, Black, Charcoal,</i> <i>Blue, Green</i>	-.30

61 Pencil Parts

<u>Part No.</u>		<u>Export Wholesale Net Price</u>
G 912-653-721-1	Clip (gold filled)	-.75
C 911-653-721-1	Clip (chrome)	-.75



Part Number

LIQUID LEAD PENCILS
Caps and Clips

41 and "21" Models

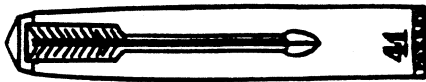

673-841 41 Satin Lustraloy Finish US\$ 1.60

673-941 Cap less Clip 1.10
~~917-596-721~~ Clip Chrome Plated -.50

596-721



713-841 SUPER "21" Satin Lustraloy Finish 1.10

713-941 Cap less Clip -.85
 713-721 Clip Chrome Plated, Stamped Arrow -.25



713-841-1 SUPER "21" Satin Lustraloy Finish ~~1.10~~

713-941-1 Cap less Clip 1.00
 713-721-1 Clip ~~-.85~~
 Chrome Plated Arrow Clip -.25

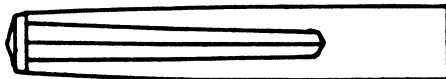

576-841 "21" Custom Gold-filled 3.25

576-941 Cap less Clip 2.75
 947-609-721 Clip Rolled Gold Plate -.50

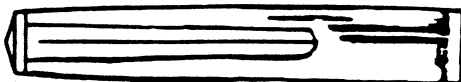

574-841 "21" Deluxe Bright Lustraloy Finish 1.50

574-941 Cap less Clip 1.00
 947-609-721 Clip Rolled Gold Plate -.50

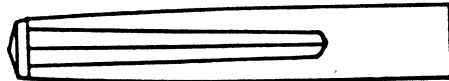

612-841 "21" Standard Satin Lustraloy Finish 1.00

575-941-1 Cap less Clip -.70
~~612-941~~ Clip Chrome Plated -.30
 787-609-721

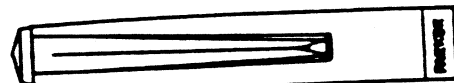

575-841-1 "21" Special Satin Lustraloy Finish 1.00

575-941-1 Cap less Clip -.70
~~612-941~~ Clip Chrome Plated -.30
 573-721

Part Number

LIQUID LEAD PENCILS
Caps and Clips

Neuter Models



636-841

LL-395

Satin Lustraloy Finish

US\$ -.80

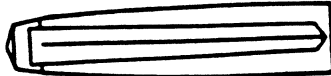

645-841

LL-295

Satin Lustraloy Finish

-.50

LL-275

41 Pencil
Repair Parts Price List

Export Wholesale
Net Price

Part No.

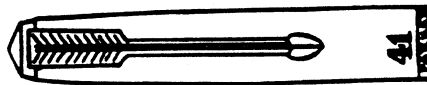

673-841

Lustraloy Cap with Clip

1.50

673-941

Lustraloy Cap less Clip

1.00

596-721

Clip (Chrome)

-.50

400-897



Clip Screw Bushing

-.05

400-811



Clip Screw

-.03

633-950

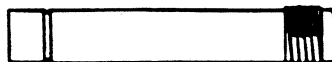

Eraser Cup Holder Assembly

-.15

639-704

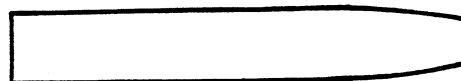

Barrel

-.30

Colors: Charcoal, Light Green, Coral, Turquoise,
Black

639-705



Barrel Point

-.20

Add the word "International" after the following numbers:

653-897 61 Clip Screw Bushings

653-811-1 61 Clip Screws

Part Number

LIQUID LEAD PENCILS
Parts for Caps

All Models

Clip Screw Bushings



653-897

61

US\$ -.05



400-897

"51"
41



-.05



Clip Screws

653-811-1

61

-.05



400-811
Black
or
Grey

"51", All Models except "51" Special - Grey
"51" Special }
41 } Black

-.05



609-811

SUPER "21"
"21" Special, Standard
"21" Custom, Deluxe

Chrome Plated

-.05

611-811

Gold-filled

-.25

Cap Liner Assemblies

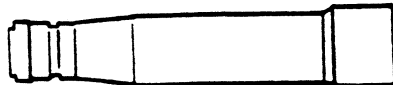

663-740

61 (Cap Liner and Bushing Assembly)

-.15

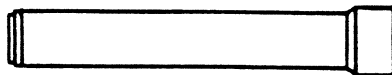

433-740-B

"51" Standard

-.15

566-740-B

"51" Demi

-.15

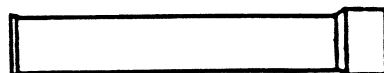

609-740

SUPER "21"
"21"

-.15

LIQUID LEAD PENCILS
Barrels

Part Number

All Models



663-704

61

US\$ -.40

Colors: Black, green, blue, charcoal, red

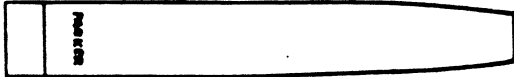

649-884

"51" Presidential
(Barrel Assembly)

14K Gold

20.00



648-884

"51" Insignia Aero-metric
(Barrel Assembly)

Gold-filled

2.70

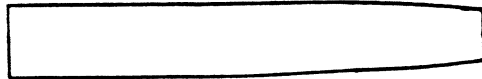

651-884

"51" Fighter
(Barrel Assembly)

Satin Lustraloy Finish

2.10

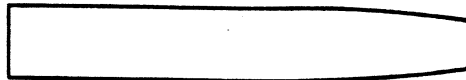

633-704

"51" Standard

-.40

638-704

"51" Demi

-.40

Colors: Black, midnight blue, navy grey, cocoa,
forest green, burgundy, teal blue

"51" Special, Demi

Colors: Black, navy grey, forest green, burgundy,
teal blue



639-704

41

-.40

Colors: Black, light green, coral, aqua blue, charcoal

SUPER "21"

Colors: Black, dark blue, charcoal, red, green, dusty blue

"21"

Colors: Black, blue, green, red

Part Number

LIQUID LEAD PENCILS
Barrels and Eraser Cup Holders

All Models



636-907 LL-395 (Barrel Assembly) US\$ -.40

Colors: Black, red, grey, purple, turquoise

LL-295 (Barrel Assembly) -.40

Colors: Black, charcoal, green, red



671-907 LL-275 (Barrel Assembly) -.30

Colors: Black, deep blue, grey, red, coral,
turquoise, light blue

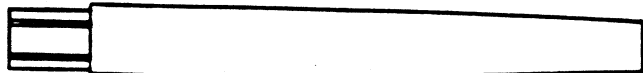

674-923 LIQUID LEAD Desk Pencil for Ballpoint Desk Set
(Barrel Assembly) -.80

Color: Black only



674-896 Taper (not drilled for chain) -.30

686-896 Taper (drilled for chain) -.30

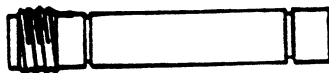

Eraser Cup Holders

653-950 61 Connector and Eraser Cup Holder -.30

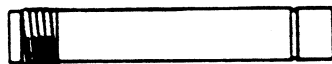

633-950 "51" .41 -.30







SUPER "21"
"21"

674-950 LIQUID LEAD Desk Pencil -.15

LIQUID LEAD PENCILS
Points

All Models

Part Number

			
659-870	61, All Gold-filled Models (Barrel Point Assembly)	Gold-filled Trim Chrome Plated Point with Gold-filled Trim Ring	US\$ -.30
653-870	61, All Nickel Trim Models (Barrel Point Assembly)	Chrome Plated Trim Chrome Plated Point	-.30
			
648-705	"51" Presidential "51" Insignia, Std. and Demi	Gold-filled	1.20
			
651-705	"51" Flighter	Chrome Plated	-.45
			
633-705	"51", All Plastic Models except "51" Special "21" Custom	Chrome Plated	-.40
			
639-705	"51" Special, Std. and Demi 41 SUPER "21" "21", Deluxe, Special and Standard	Chrome Plated	-.20
			
636-705	LL-395 LL-295 LL-275	Chrome Plated	-.20
			
674-705	LIQUID LEAD Desk Pencil		-.20

Part Number

BALLPOINTS
Caps and Clips

"51" and "21" Models

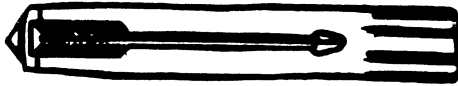

712-180	Insignia Ballpoint	Gold-filled	US\$ 3.50
---------	--------------------	-------------	-----------

570-702	Cap less Clip		2.75
918-596-721	Clip	Rolled Gold Plate	-.75

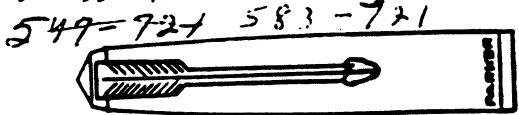

624-180	"51" Aero-metric	Gold-filled	3.50
---------	------------------	-------------	------

587-702	Cap less Clip		2.75
918-596-721	Clip	Rolled Gold Plate	-.75

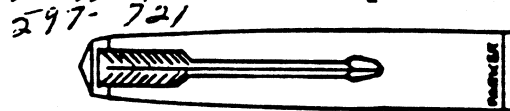

623-180	"51" Aero-metric	Satin Lustraloy Finish	2.00
---------	------------------	------------------------	------

586-702	Cap less Clip		1.50
917-596-721	Clip	Chrome Plated	-.50

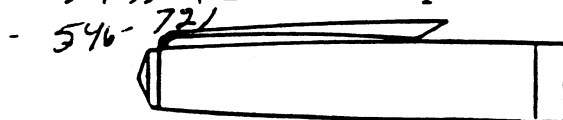

632-180	"21" Special	Satin Lustraloy Finish	1.00
---------	--------------	------------------------	------

632-002	Cap less Clip		-.70
917-632-013	Clip	Chrome Plated	-.30

632-013

Add:	772-180	International Presidential 14K Gold	Price	\$ 17.00
	772-002	Cap less Clip less ratchet assembly	Price	\$ 13.80
	728-721	Clip 14K Gold	Price	\$ 3.00
	771-180	International Insignia Gold-filled	Price	\$ 3.50
	771-002	Cap less Clip less ratchet assembly	Price	\$ 2.55
	*770-721	Clip Gold Electroplated	Price	\$ -.75
	770-180	International Fighter Lustraloy	Price	\$ 2.00
	770-109	Cap less Clip less ratchet assembly	Price	\$ 1.05
	*770-721	Clip Gold Electroplated	Price	\$.75

BALLPOINTS
Caps and Clips

Part Number

756-180	Executive Insignia	Gold-filled	US\$ 3.50
756-002	Cap less Clip		3.00
755-013	Clip	Rolled Gold	-.50
755-180	Executive Gold-fill	Gold-filled	3.50
755-002	Cap less Clip		2.75
755-013	Clip	Rolled Gold	-.50
770 - 013		<i>Hard Electroplated</i>	<i>1.00</i>
754-180	Executive Lustraloy	Bright Lustraloy Finish	1.75
754-002	Cap less Clip		1.25
754-013	Clip	Chrome Plated	.50
653 - C13 - 1			<u>Cap Assemblies</u>
737-180	Minim Presidential	14K Gold	6.25
733-180	Minim Insignia } Minim Gold-fill }	Gold-filled	2.25 1.60
748-180	Ivy Black Cap } Ivy White Cap } Ivy All Black } Ivy All White }	Engraved design on lacquered metal cap	2.50
	Colors: Black or White		
752-180	All Engraved	Engraved design on lacquered metal cap	2.00
	Color: Black		
750-180	All Engraved	Engraved design on lacquered metal cap	2.00
	Colors: Blue, Beige, Turquoise, Pink		
749-180	Engraved Cap	Engraved design on lacquered metal cap	1.25
	Color: Black		
747-180	Engraved Cap	Engraved design on lacquered metal cap	1.25
	Colors: Blue, Beige, Turquoise, Pink		
753-180	Debutante	Engraved design on lacquered metal cap	1.25
	Colors: White, Blue, Beige, Turquoise, Pink		

Part Number

BALLPOINTS
Caps and Clips
Neuter Models

#705-013 Clips best. 023 on fabric

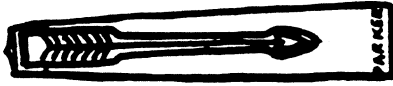

705-180

T-BALL All Metal Ballpoint (1957)
Bright Lustraloy Finish

US\$ -.75

T-BALL Deluxe Ballpoint (1957)

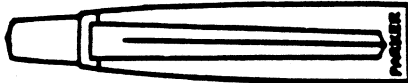

671-180

T-BALL Ballpoint (1957)
Bright Lustraloy Finish

-.45

(Also fits old style All Metal, Jotter and Standard
Jotter models.)

671-013

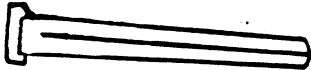

Phosphor Bronze Clip

-.25

Add:

717-180

T-BALL Ballpoint (1957) Bright Lustraloy Finish
(Also fits old style All Metal, Jotter
and Standard Jotter Models)

-.70

Add:

780-180

T-BALL Ballpoint (Pardner)
(with Arrow clip)

Price \$.45

Add: 770-811	Clip Screw, International Flighter and Insignia	Price \$	-.05
770-097	Clip Screw Bushing, International Flighter and Insignia	Price \$	-.05
770-346	Ratchet Frame Assembly, All International Models	Price \$	-.20
770-293	Ratchet Frame, All International Models	Price \$	-.06
770-321	Plunger Bushing, All International Models	Price \$	-.05
770-125	Plunger, All International Models	Price \$	-.05
770-289	Spring, All International Models	Price \$	-.05
717-293	Ratchet Frame Assembly, T-BALL Ballpoint	Price \$	-.12
717-125	Plunger, T-BALL Ballpoint	Price \$	-.05
717-288	Button, T-BALL Ballpoint	Price \$.06
717-289	Spring, T-BALL Ballpoint	Price \$.05

Part Number



BALLPOINTS
Cap Mechanisms and Parts

All Models

Clip Screw Bushings

	400-897	Insignia "51"		US\$ -.05
---	---------	------------------	---	-----------



Clip Screws

	400-811	Insignia "51"	Grey	-.05
	609-811	"21" Special	Chrome Plated	-.05

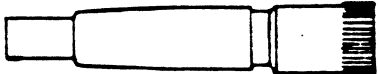
Ratchet Frames

	623-322	Insignia "51" "21" Special	Assembly	-.25
	705-322	Executive Gold-fill Executive Lustraloy		.20

Plunger Bushings

	623-321	Insignia "51"		-.05
	632-321	"21" Special		-.05
	754-352	Executive Gold-fill Executive Lustraloy		-.05

Add the following as Page 54A

Export Wholesale
Net Prices

BALLPOINTS
Minim Caps

Part Number

Cap Liner

731-344 Minim Presidential)
 Minim Insignia)
 Minim Gold-fill)

Brass

US\$-.15

Button

737-288 Minim Presidential

14K Gold

1.75

733-288 Minim Insignia)
 Minim Gold-fill)

Gold Colored Metal

-.25

Toggle Spring

731-055 Minim Presidential
 Minim Insignia
 Minim Gold-fill

-.05

Outer Cap

737-002 Minim Presidential

14K Gold

4.35

733-002 Minim Insignia)
 Minim Gold-fill)

12K Gold-filled

1.85

Add: 772-298

Barrel, International
 Presidential

14K Gold Price \$ 20.00

771-298

Barrel, International
 Insignia

Gold-filled Price \$ 3.00

770-298

Barrel, International
 Fighter

Lustraloy Price \$ 1.50

Part Number

BALLPOINTS
Barrels

"51" and "21" Models



712-279

Insignia Ballpoint
(Barrel Assembly)

Gold-filled

US\$ 2.70



624-279

"51" Gold-filled
(Barrel Assembly)

1.10

623-279

"51" Lustraloy
(Barrel Assembly)

1.10

Colors: Black, midnight blue, navy grey, cocoa,
forest green, burgundy, teal blue

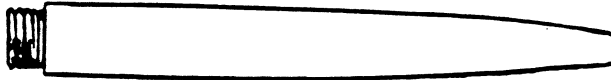

~~622-004~~

717-338

"21" Special

-.30

Colors: Black, ^(deep)blue, green, red, *light blue*

Standard Jotter Ballpoint (old style)

Colors: Black, charcoal, coral, turquoise

(Also fits Plastic Ballpoint Desk Set)

Barrel Bands

669-096

Ballpoint Desk Pen

-.05

734-248

*T Ball all Metal Ballpoint - includes
connector (Ridges on lower half of barrel) 75*

Part Number

**BALLPOINTS
Barrels**

Neuter Models

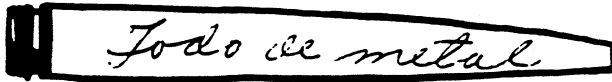

718-298

**T-BALL All Metal Ballpoint (1957)
(Barrel Assembly)
Also fits old style All Metal and
Metal Barrel Ballpoint Desk Set**

US\$ -.75

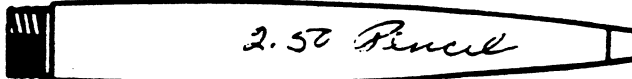

705-338

**T-BALL Deluxe Ballpoint
(Barrel Assembly)**

*Para a cap. de botex
e para a. de a mesma
cap. de T-Ball de metal
modelo (cap. de botex)*

-.35

Colors: Black, blue, charcoal, grey, green, red

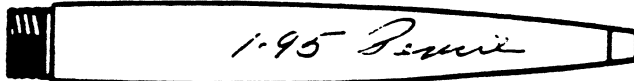

717-338

**T-BALL Ballpoint (1957)
(Barrel Assembly)**

Also fits old style Jotter

*Cap. de 1.95 mm
para a. de 1.95 mm
para a. de 1.95 mm
para a. de 1.95 mm*

**-.25
-.35 30**

**Colors: Black, deep blue, grey, green, red,
light blue**





Standard Jotter Ballpoint (old style)

(See "21" Models, Page 55)

BALLPOINTS
BarrelsPart Number

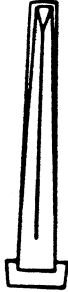
737-298	Minim Presidential	14K Gold	US\$ 6.25
733-298	Minim Insignia	Gold-filled	2.00 2.20
731-004	Minim Gold-fill	Plastic	-.30 .25
	Colors: Black, Grey, Deep Blue, Red		
756-279 712-279	Executive Insignia <i>barrel</i>	Gold-filled	3.00
755-338	Executive Gold-fill Executive Lustraloy	Plastic	-.75
	Colors: Black, Charcoal, Grey, Deep Blue, Red and Green		
753-338	Debutante	Plastic	-.30
	Colors: White, Blue, Beige, Turquoise, Pink		
751-298	Ivy Black Cap) Ivy White Cap)	Gold Electroplated (Bright Finish)	2.50
748-338	Ivy All Black) Ivy All White)	Plastic	-.75
	Colors: Black, White		
752-298	All Engraved	Engraved design on lacquered metal barrel	1.90
	Color: Black		
750-298	All Engraved	Engraved design on lacquered metal barrel	1.90
	Colors: Blue, Beige, Turquoise, Pink		
747-298	Engraved Cap	Gold Electroplated (Satin Finish)	1.50

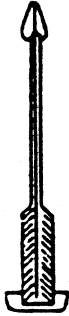
Clips

<u>Part No.</u>		<u>Used For</u>	<u>Export Wholesale Net Price</u>
620-013	Phosphor Bronze	 All Metal Jotter	-.27
917-596-721	Lustraloy	 "51" Lustraloy	-.50
918-596-721	Gold-filled	 "51" Gold-fill	-.75
917-632-013	Phosphor Bronze	 "21" Special	-.27

44

Part Number

BALLPOINTS
Parts for Barrels

All Models

Retracting Springs



620-294-1

All Ballpoints
(old and new)

(per 100)

US\$ -.50

Barrel Points



624-278

Insignia

Rolled Gold Plate

-.20

Barrel Connectors



623-052

"51" Gold-filled
"51" Lustraloy

-.10

712-052

Executive Gold-filled
" Lustraloy

.10

Tip Bushings



621-299

All Metal Jotter

-.05

99-050-507

Magnet Escutcheon Assembly for
Ceramic Desk Sets only.

US\$ 2.50

Note: This Assembly has a thin, wide magnet and is to be used only with the Ceramic Desk Sets. The bases for the Magnetix Desk Sets are drilled for an assembly which is thicker but has a smaller diameter.

Add:

99-050-555

Spherix Assembly

1.50

Note: This assembly is to be used on the new Ceramic Desk Set Bases and is built to accommodate ballpoint desk pens.

Part Number

DESK SETS
Parts

Spherix

99-080-664
(Assembly)

Parker Desk Pen
Hour Glass - Spherix

US\$ 2.00

99-080-663
(Retainer only)

1.50

99-080-653
(Bowl only)

-.50

99-080-625

Screw for above

-.05

99-080-577
(Assembly)

"51" Spherix

1.00

99-080-611-1
(Bowl only)

"51" Spherix

-.50

99-080-552
(Assembly)

"21" Spherix

1.20

99-080-551
(Retainer only)

"51" and "21" Spherix

-.70

99-080-612-1
(Bowl only)

"21" Spherix

-.50

Two new Desk Set models; a desk ballpoint and a desk mechanical pencil have been added to the line.

<u>Part Number</u>		DESK SETS
746-338	Barrel and Point Assembly (plastic with gold colored metal point)	Ballpoint Desk Pen US\$-.75
746-096	Barrel Band (gold colored metal)	-.30
746-245	Taper and Tip Assembly (plastic with gold colored metal tip)	1.10
		Mechanical Desk Pencil
746-096	Barrel Band (gold colored metal)	US\$-.30
746-704	Barrel (plastic)	-.50
746-886	Mechanism	-.65
746-705	Point (gold colored metal)	-.30
746-901	Taper and Tip Assembly (plastic with gold colored metal tip)	1.10

Parts for JUNIOR and SUB-DEB VACUMATIC PENS

Available from Toronto
1 March 1958

<u>Part Number</u>			<u>Caps and Clips</u>
G-404-180	Sub-Deb Vacumatic	1 Medium Wide Band	US\$ 1.50
G-404-160	Cap less Clip		1.00
G-221-013	Clip	Rolled Gold Plate	-.50
	Colors: Blue, brown, burgundy, green		
G-404-180A	Sub-Deb Vacumatic	1 Wide Embossed Band	1.50
G-404-160A	Cap less Clip		1.00
G-221-013	Clip	Rolled Gold Plate	-.50
	Colors: Blue, brown, burgundy, green		
C-409-180	Sub-Deb Vacumatic	1 Medium Wide Band	1.50
C-409-160	Cap less Clip		1.00
C-223-013	Clip	Chrome Plated	-.50
	Color: Grey		
G-410-180	Junior Vacumatic	2 Narrow Bands	1.50
G-410-160	Cap less Clip		1.00
G-196-013	Clip	Rolled Gold Plate	-.50
	Colors: Black, blue, brown, green, burgundy		
G-410-180A	Junior Vacumatic	1 Wide Embossed Band	1.50
G-410-160A	Cap less Clip		1.00
G-196-013	Clip	Rolled Gold Plate	-.50
	Colors: Black, blue, brown, burgundy, green		
C-399-180	Junior Vacumatic	2 Narrow Bands	1.50
C-399-160	Cap less Clip		1.00
C-199-013	Clip	Chrome Plated	-.50
	Color: Grey		
			<u>Barrels</u>
404-140-1	Sub-Deb Vacumatic		1.35
	Includes: Plain blind cap, section and filler unit		
	Colors: Blue, brown, burgundy, grey		

Barrels (contd.)

220-003-1	Blind cap only		-.40
	Colors: Blue, brown, green, burgundy		
410-140-1	Junior Vacumatic		1.35
	Includes: Plain blind cap, section and filler unit		
	Colors: Black, blue, brown, green, burgundy		
195-003-1	Blind cap only		-.40
	Colors: Black, blue, brown, green, burgundy		

Blind Cap Screws

74-062	Sub-Deb and Junior Vacumatic, Black only		-.05
--------	--	--	------

Nibs

137: Rigid 143: Flexible	Junior Vacumatic	14K Gold	1.50
119: Rigid 152: Flexible	Sub-Deb Vacumatic	14K Gold	1.50

Nib Assemblies

404	Sub-Deb Vacumatic		1.65
410	Junior Vacumatic		1.65

Above assemblies include: nib, feed, tube and section.

Feed and Tube Assemblies

220-260	Sub-Deb Vacumatic		-.10
410-260	Junior Vacumatic		-.10

Filler Unit

316-084-C	Sub-Deb and Junior Vacumatic		-.25
444-048	Diaphragm for above Filler Unit		-.05

Sections

220-005	Sub-Deb Vacumatic		-.05
224-005	Junior Vacumatic		-.05

Clip Screw Bushings

74-097-A	Sub-Deb and Junior Vacumatic		-.05
----------	------------------------------	--	------

Clip Screws

51-811A	Sub-Deb and Junior Vacumatic Black		-.05
---------	------------------------------------	--	------

THE PARKER PEN COMPANY

JANESVILLE, WIS., U. S. A.



Bulletin for Parker Distributors

No. 485

Date 20 de Noviembre de 1958

Subject: **SERVICIO:** Rajaduras de la Cápsula de la Parker 61

Habiendo recibido algunas quejas con respecto a grietas en la cápsula de plumas 61 reparadas en los mercados foráneos, hemos efectuado una investigación que descubre algunos datos interesantes.

Cementos y Disolventes: Algunas de las plumas examinadas demostraron que algunos de los cementos usados en la rosca del conector no eran del tipo recomendado.

Recomendamos el uso de los Cementos Nos. 720 ó 1182, que suministramos nosotros. Si las restricciones de importación en su país no les permiten obtener estos cementos, sugerimos que obtengan, localmente, una solución orgánica de caucho o de resina en hidrocarburos alifáticos. Estos cementos no deben contener alcohol, acetona ni ninguno de los disolventes del tipo de hidrocarburos aromáticos. Cementos con este tipo de disolventes afectan el plástico y pueden ser responsables de las grietas en la cápsula de la 61.

Si es del todo posible, importe los Cementos Nos. 720 ó 1182.

Si estos cementos se espesan, use un adelgazador en la forma de un hidrocarburo alifático. Recomendamos la "Bencina de petróleo". Cerciórese de que se trata de el destilado de petróleo y no un destilado de carbón de hulla, ya que este último agravará el problema.

El cemento seco, viejo, debe ser limpiado de la rosca del conector. Use para esto un cepillo de cerdas duras y, nuevamente, recomendamos el uso de un disolvente en la forma de un hidrocarburo alifático, tal como la Bencina.

Torsión Correcta: Cierta número de las plumas examinadas mostraban grietas o rajaduras en la cápsula debido al uso de fuerza exagerada al apretar la rosca de la cápsula. Extremo cuidado debe ejercerse al apretar la cápsula, usando solamente la fuerza mínima necesaria para hacer un buen ajuste.

Sello: La banda plástica circular, o "sello", que se encuentra sobre la cápsula de la celda entre el colector y el conector metálico, debe ser cuidadosamente examinado. Un sello torcido se arrugará al apretar el conector causando presiones contra la superficie interna de la cápsula plástica, que resultarán en rajaduras de la misma.

La observación de estos puntos en la reparación de plumas 61 es considerada de suma importancia, y agradeceremos su cooperación.

Muy atentamente,

División de Exportación

Ross O. Fowler
DHS/rjh

INDICE

	<u>Page</u>	
PLUMAS	Tapas y Sujetadores	1 - 8
	Repuestos para Tapas	9 - 10
	Cañones	11- 15
	Repuestos para cañones - Anillos -	16
	Anillos de Amarre y Arandelas	17- 18
	Empalmes, Empaques	19
	Cápsulas del Colector	20- 21
	Plumillas	22
	Colectores	23
	Conjunto de Alimentador y Tubo	24
	Repuestos para unidades llenado- ras, Diafragmas	25-27
LAPICEROS MECANICOS	Tapas y Sujetadores	28- 35
	Repuestos para Tapas	36- 37
	Cañones	38- 39
	Conjunto del Mecanismo	40
	Puntas Metálicas	41
LAPICEROS DE GRAFITO LIQUIDO	Tapas y Sujetadores	42- 46
	Repuestos para Tapas	47- 48
	Cañones	49- 50
	Portaborradores	50
	Puntas Metálicas	51
BOLIGRAFOS	Tapas y Sujetadores	52- 53
	Mecanismo de la Tapa y Partes	54
	Cañones	55- 56
	Repuestos para Cañones	57
PLUMAS PARA ESCRITORIO	Conjuto de Soportepumas, Placas Metálicas y Adornos para Bases	58- 59

Todas las órdenes para los repuestos antes mencionados, estarán sujetas a lo que se encuentre disponible en los inventarios de Janesville, Wisconsin, E. U. de A.

NOTA: Los repuestos para las plumas JUNIOR y SUB-DEB VACUMATIC están disponibles en Toronto, Canadá.

Los precios están sujetos a cambios sin notificación previa.

Sírvanse especificar en las órdenes, el número del catálogo y la descripción de los repuestos.

Para las plumas "21" hemos asignado a los modelos fabricados antes de 1953 el No. "Model 609", y a los fabricados posteriormente, excepto la pluma SUPER "21", el No. "Model 615".

A la pluma de escritorio para usarse con el soportepumas del diseño "Hour Glass", le hemos asignado la especificación "Desk Pen".

Lista de Precios para Herramientas

	<u>Precio Neto</u> <u>Exportación</u> US\$	<u>Peso Neto</u> Kgs.
<u>Alicates y Llaves</u>		
*Alicates para fijar la plumilla y el alimentador a secciones de plumas Vacumatic	2.95	.270
*Alicates para espaciar y ajustar las plumillas	4.90	.030
*Alicates para remover la sección y cápsula del colector, del cañón de plumas Vacumatic	4.00	.135
*Alicates, No. 17166, para cartuchos de celda 61	3.25	.240
*Llave No. 8674, para remover o fijar unidades llenadoras de todos los modelos Vacumatic excepto del tipo "Senior lock"	6.25	.190
*Llave de sección universal, No. 12827	15.00	.165
<u>Taladros y Tarrajas</u>		
Taladro 1/32", No. 13174 para cañones de plumas y puntos de lapiceros	-.80	.015
Terraaja, No. 37, para cañón "51" Vac-fil	4.00	.045
<u>Graduadores y Espaciadores</u>		
Graduador de plumillas, No. 11593 (Regular) para calibrar las plumillas	3.50	.060
Graduador de plumillas, No. 11594 (Extrafino y contabilidad) para calibrar las plumillas	3.50	.060
Espaciador de Plumillas, No. 993-R2 para ajustar las plumillas	-.50	.030
*Espaciadores y Limpiadores (10 a -.04 c/u)	-.40	.015
Formón, No. 86758, para tapitas "51" y cañones 61, para tornos de mesa - Punta de Carburo -	2.30	.060
<u>Misceláneos</u>		
Lima Plana	-.50	.060
*Tubo de goma para alicates de sección, por pie	-.45	.045
*Tira de goma (para palma de la mano)	-.01	.015
Extractor de plumillas, No. 8573R1, para remover la plumilla de la cápsula del colector de plumas "51"	-.10	.015

(*) Denota herramientas básicas)

Lista de Precios para Herramientas

	<u>Precio Neto</u> <u>Exportación</u>	<u>Peso Neto</u>
<u>Misceláneos (Cont.)</u>		
*Lupa de aumento (para inspeccionar las plumillas)	1.70	.045
Arbol, No. 8057, para remover o fijar los sujetadores a tapas de plumas "51"	3.00	.090
*Arbol, No. 18028, para remover y fijar sujetadores a lapiceros 61, "51" y 41	-.75	.030
*Herramienta de montaje, No. 13373, para plumas "21"	17.00	.045
*Herramienta No. 13346, pra sujetadores de lapiceros "21"	5.50	.330
Desmontador No. 16393 para tapas de bolígrafos	1.50	.330
*Bruñidor de cartuchos de celda 61, No. 17128	2.50	.060
Desmontador No. 9592-R1 para plumas Vacumatic	2.25	.165
Bomba (Perilla) de goma, extractora de tinta para la 61	-.50	.030
Limpiador centrífugo No. 957S (manual-servicio liviano)	1.00	.780
*Quemador de Alcohol	1.50	.180
<u>Cementos</u>		
*Cemento No. 122 - Envase de 30 grms. para pluma 61	-.25	.030
*Cemento No. 720 - Envase de 30 grms. para pluma 61	-.25	.030
*Cemento No. 1128 - 1 Oz. (frasco) (puede sustituir al No. 720 para todas las plumas)	-.25	.030
(Los cementos Nos. 720 y 1128 pueden ser aclarados con líquido de encendedores o con gasolina clara)		
<u>Detergentes (Para plumas 61)</u>		
A-11 - Paquete de 480 grms. (Disuélvase 15 grms. de A-11 en 480 grms. de agua - Debe prepararse al tiempo de usarse) Para someter la pluma después de reparada.	-.50	.480
QHD - Paquete de 480 grms. (Disuélvase 5 grms. de QHD en 960 grms. de agua - Puede prepararse previamente para el uso diario.	1.00	.480
<u>Pulidores</u>		
Pómez - Barra de 960 grms.	1.00	.960
Cera Blanca - Barra de 720 grms. (Tambien para pulir oro)	1.50	.720
Rueda Pulidora de Algodón de 6" de diám. (6 secciones)	1.80	.420
Rueda Pulidora de Algodón de 8" de diám. (6 secciones)	2.70	.600
Tela especial (de joyero) para pulir	-.45	.060
Los materiales anteriormente descritos se usan solamente en pulidores mecánicos, excepto la tela.		
Papel Hubert - 1 hoja (#000 Rouge)	-.10	.015

Las siguientes herramientas pueden obtenerse localmente:

Quemador de Alcohol, Alicates para fijar la plumilla, Lima Plana, Tira de Goma y Lupa de Aumento.

(*) Denota herramientas básicas.

LL PENCIL BARREL

674-704	LL Desk Pencil Barrel	- .80
---------	-----------------------	-------

LL PENCIL CAPS

713-841-1	SUPER "21" w/clip	1.25
713-941-1	SUPER "21" 1/clip	1.-
575-841-1	"21" Special w/clip	1.25
575-941-1	"21" Special 1/clip	1.-

COLLECTOR SHELLS

728-189	61 Presidential Shell Assembly w/14K Insert	1.-
729-189	61 Insignia Shell Assembly w/1/10 12K Gold Insert	- .65

BARREL BANDS

728-096	61 Presidential	2.50
729-096	61 Insignia	- .30

BARRELS

728-332	61 Presidential (w/sealing valve)	33.-
729-332	61 Insignia (w/sealing valve)	5.-

PEN CAPS

728-180	61 Presidential	33.-
(Less Clip - 728-160)		29.-
730-180	61 Insignia	5.-
(Less Clip - 730-160)		4.-

BALLPOINT MECHANISMS

705-322	Ratchet Frame & Plunger Assembly, Executive	- .20
754-352	Plunger Bushing and Adapter Assembly, Executive	- .05

BALLPOINT BARREL CONNECTOR

712-052	Executive	- .10
---------	-----------	-------

PEN CLIPS

713-013	Super "21" - Stamped Arrow - Delete (No Longer Available)	
---------	--	--

Add the following as Page 1A

Export Wholesale
Net Prices

PENS
Caps and Clips

Part Number

728-180	61 Presidential	14K Gold	US\$33.00
728-160	Cap less Clip		29.00
728-013	Clip	14K Gold	4.00
730-180	61 Insignia	Gold-filled	5.00
730-160	Cap less Clip		4.00
659-013	Clip	Rolled Gold Plate	1.00
770-013		<i>Gold Electroplated</i>	
779-180	<i>61 Jet Flighter</i>	<i>Cap - Australia</i>	<i>2.25</i>
779-180	<i>" " " " "</i>	<i>less clip</i>	<i>1.50</i>

PENCIL CAPS - (Cont'd)

754-841	Executive, Lustraloy	2.50
(Less Clip -- 754-702)		2.-
645-841	Pardner	-.70

PENCIL CLIPS

713-721	Delete this item on pages 33 & 45 - as no longer available	
728-721	61 Presidential, 14K Gold	3.-
659-721	61 Insignia, Rolled Gold	-.75
754-013	Executive, Chrome Plated	-.50
755-013	Executive, Rolled Gold	40 .50

PENCIL MECHANISM

717-881	Pardner Pencil	-.40
609-866	For Rotary Pencil - No longer available - Substitute w/725-866-1 for all Rotary except Parkette and 51 Demi	

PENCIL CLIP SCREWS

653-811-1	Pages 36 and 47 (Note: Only for 61 pencils)	
-----------	--	--

CAP LINER ASSEMBLY

754-740	Executive	-.15
---------	-----------	------

BALLPOINT BARRELS

737-298	Minim, 14K Gold	6.25
756-279	Executive, 12K Gold Filled	3.-
751-298	Princess (Bright Finish)	2.50
733-298	Minim (12K Gold Filled)	2.-
752-298	Princess, Black	1.90
750-298	Princess Blue, Beige, Turquoise, Pink	1.90
747-298	Princess (Tumble Finish, \$5.- Model)	1.50

PEN CLIPS - (Cont'd)

573-013	"21" Special	-.40
787-609-013	"21" Standard	-.40
728-013 (14K Gold)	61 Presidential	4.-
659-013 (Rolled Gold)	61 Insignia	1.-

PEN CLIP SCREWS

653-811-1	61 Pen (Page 9) use this number instead of 653-111-1	
-----------	---	--

MAGNET ESCUTCHEON ASSEMBLY

99-050-507	Ceramic	2.50
------------	---------	------

PENCIL POINTS

728-705	61 Presidential and Insignia (Gold Electroplated)	-.60
755-705	Executive (Gold Electroplated)	-.30
725-705	Executive (Chrome Plated)	-.30

PENCIL BARRELS

728-840	61 Presidential	19.-
729-840	61 Insignia	3.50
754-704	Executive Black, Charcoal, Grey, Deep Blue, Red and Green	-.50
717-907	Pardner (Eraser & Cup Assembly)	-.30

PENCIL CAPS

728-841	61 Presidential	19.-
(Less Clip -- 728-702)		16.-
730-841	61 Insignia	3.75
(Less Clip -- 730-702)		3.-
755-841	Executive	2.75
(Less Clip -- 755-702)		2.25

BALLPOINT BARRELS - (Cont'd)

748-338	Princess Black, White	-.75
755-338	Executive Black, Charcoal, Grey, Deep Blue, Red or Green	-.75
753-338	Debutante White, Blue, Beige, Turquoise, Pink	-.30
717-338	Pardner Black, Grey, Red, Light Blue or Green	-.30
731-004	Minim Black, Grey, Deep Blue, Red	-.30

BALLPOINT CAPS

737-180	Minim, 14K Gold	6.25
756-180	Executive, 12K Gold Filled	3.50
(Less Clip -- 756-002)	(\$12.50 Model)	3.-
755-180	Executive, 12K Gold Filled (\$8.75 Model)	3.50
(Less Clip -- 755-002)		2.75
748-180	Princess Black or White	2.50
754-180	Executive, Lustraloy	1.75
(Less Clip -- 754-002)		1.25
733-180	Minim, 12K Gold Filled	2.25
752-180	Princess, Black	2.-
750-180	Princess Blue, Beige, Turquoise, Pink	2.-
749-180	Princess, Black	1.25
747-180	Princess Blue, Beige, Turquoise, Pink	1.25
753-180	Debutante White, Blue, Beige, Turquoise, Pink	1.25
717-180	Pardner, (Cap and Clip)	-.70

BALLPOINT CLIPS

755-013	Executive - Rolled Gold	-.50
754-013	Executive - Chrome Plated	-.50